

## CERRADURAS ELECTRICAS DE SEGURIDAD, MEDIDAS INTERNAS DE LA CAJA (CUERPO) Y DE LOS DIVERSOS ESCUDOS.

### Dimensiones

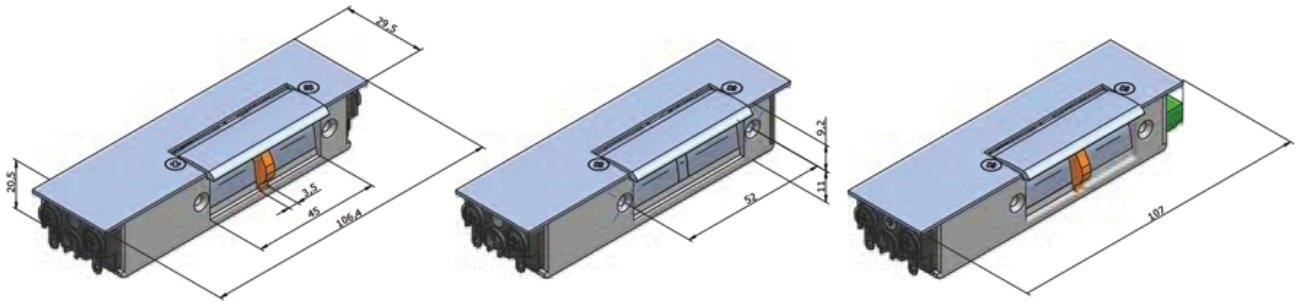

### frontales para abrepuertas de seguridad

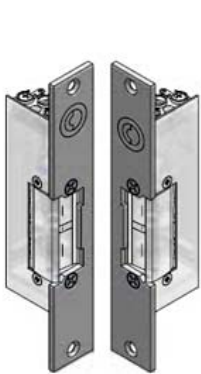

Reversible

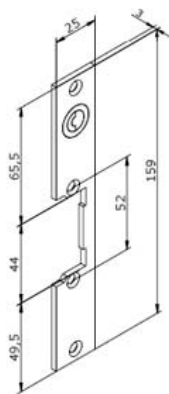

**61**  
INOX 3mm

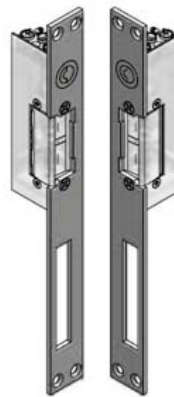

Reversible

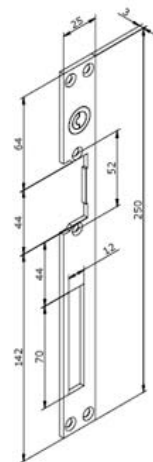

**43**  
INOX 3mm

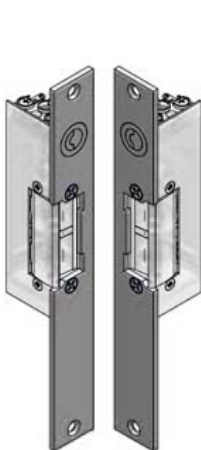

Reversible

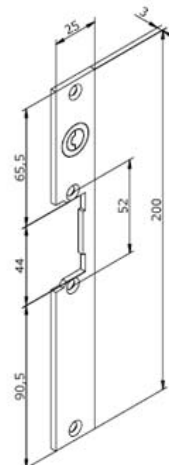

**66**  
INOX 3mm

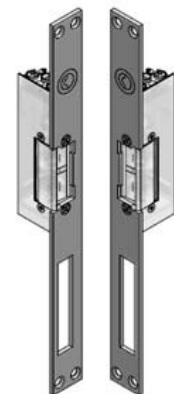

Reversible

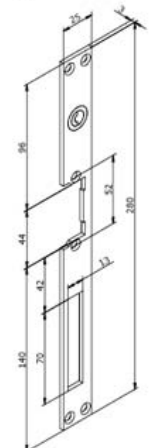

**67**  
INOX 3mm